



Please scan the QR code to get mobile app and more support to help the installation.

YC600 Microinverter Quick Installation Guide

Step 1. Verify the grid voltage to match with microinverter rating

Step 2. The AC bus distribution

- a. The AC bus is arranged at the proper position of the microinverter.
- b. One end of the AC bus access junction box/AC Isolator into power grid.
- c. **Wire the conductors of the AC bus: L - BROWN; N - BLUE; PE - YELLOW GREEN.**

NOTE: Wiring colour code can be different according local regulation, check all the wires of the installation before connecting to the AC bus to be sure they match. Wrong cabling can damage irreparably the microinverters, such an issue is not covered by the warranty.

Step 3. Attach the APsystems microinverters to the racking

NOTE: Do not place the microinverters (including DC and AC connectors) where exposed to the sun, rain or snow, even gap between modules. Allow a minimum of 3/4”(1.5cm) between the roof and the bottom of the microinverter to allow proper air flow. The racking of install microinverter must be reliably grounding.

NOTE: Forbidden to hand carry the inverter through AC cable.

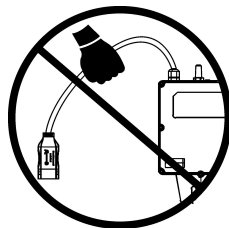

- a. Mark the location of the microinverter on the rack, with respect to the PV module junction box / AC Isolator or any other obstructions.
- b. Mount one microinverter at each of these locations using hardware recommended by your module racking vendor. When install microinverter, grounding washer Must be facing the racking.

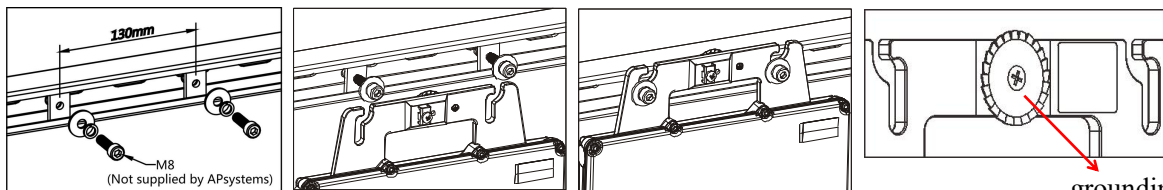

grounding washer
(Warning injure hand)

Step 4. Ground the system

- a. There already has earth wire inside the AC cable, thus the grounding work could be done directly by it.
- b. For those areas that have special requirements, the external grounding work could be done by grounding brackets.

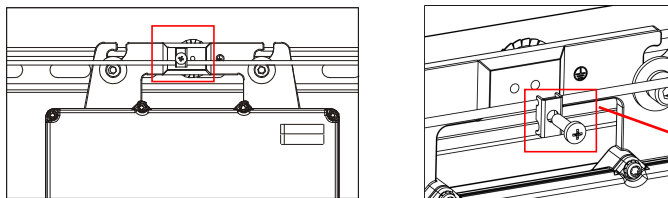

grounding brackets

Step 5. Connect the APsystems microinverter to AC bus cable

Push the microinverter AC connector to the Bus cable connector. Listen for the "Click".

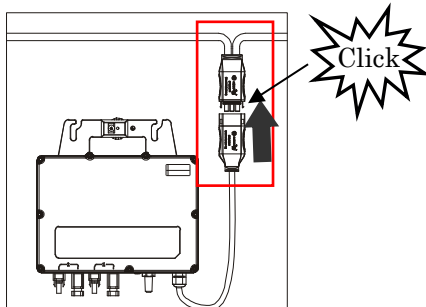

Best Practice: Use the Bus Cable Unlock Tool to split the connectors.

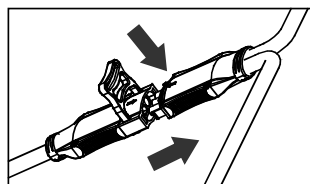

NOTE: AC connector interface as follows.

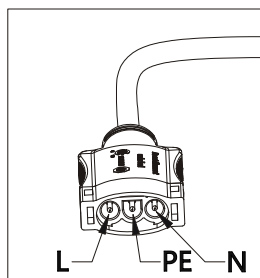

NOTE: Cover any unused connectors with Bus Cable Y-CONN Cap to protect the connectors.

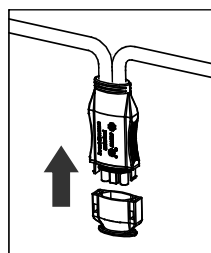

Step 6. Install a Bus Cable End Cap at the end of AC bus cable

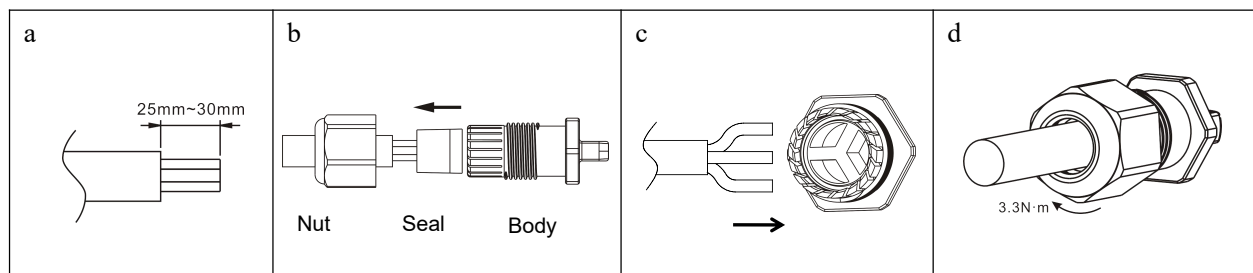

Step 7. Place the PV modules and connect each YC600 to the PV modules

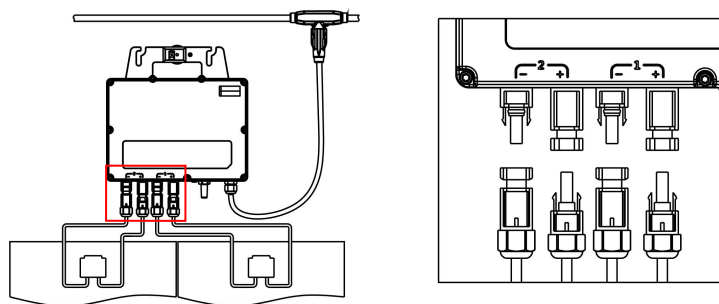

Step 8. Complete the APsystems installation map

- Each APsystems microinverter has removable serial number labels.
- Peel labels off, affix one to the respective location on the APsystems installation map, and fill in 1,2 in the label below, according to the layout on the roof.
- The other one serial number label, posted on the solar module frame is easy to view the position.
- After the completion of installation drawings sent to APsystems website www.APsystems.com.

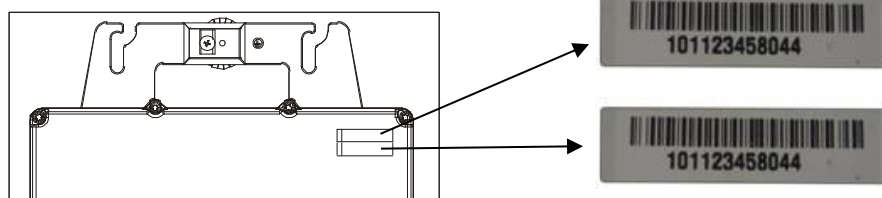

NOTE: Sequence of steps 1~8 can change for convenience of installation.

NOTE: Using APsystems' mobile app ArrayApp can make the installation and registration much more simple.

Step 9. Start the operation

- Turn on the AC circuit breaker on each microinverter AC branch circuit.
- Turn on the main utility-grid AC circuit breaker. Your system will start producing power after a two-minute waiting time.